

Spec sheet

Invoq | miniCombi Hood 1/1 GN



CAPACITY 6-1/1 GN

- 1/1 GN
- 2-piece rack
- 6 trays (20/40 mm) or 4 trays (60 mm)
- 4.5 kg maximum food load per tray
- 27 kg maximum food load per oven

CAPACITY 10-1/1 GN

- 1/1 GN
- 2-piece rack
- 10 trays (20/40 mm) or 6 trays (60 mm)
- 4.5 kg maximum food load per tray
- 45 kg maximum food load per oven



Big performance in a small footprint

Invoq miniCombi Condensation Hood

Pair your Invoq miniCombi with a condensation hood and unlock maximum performance in minimal space. Designed to complement the compact footprint of the miniCombi, this solution allows you to centralise your food production in even the smallest kitchens. Reduce excess heat and humidity while creating a more comfortable working environment for your team. With the Invoq miniCombi condensation hood, you get smart ventilation that matches the oven's efficiency and space-saving design.

Invoq miniCombi Ventless Hoodini

Take flexibility to the next level with the ventless Hoodini solution for Invoq miniCombi. Perfect for locations where traditional ventilation is limited or unavailable, Hoodini eliminates the need for external extraction systems. The filterless design removes grease, vapours, odours and contaminated air – without requiring filter cleaning or replacements. That means lower maintenance costs, simplified installation, and complete freedom to place your miniCombi exactly where your kitchen needs it most.

Intelligence at the tip of your finger...

Quick Select Recipes

QSR, Quick Select Recipes, is a tailored, smart interface giving you peace of mind knowing that any member of your team will perform to the highest standards with the same consistency, less waste and maximum throughput. This saves time and prevents errors.

CombiWash

Save time and reduce costs with the CombiWash automatic cleaning system. Simply select the cleaning level, and CombiWash doses the exact amount of water, detergent, and rinse aid. The closed-circuit system ensures minimal consumption and no contact with chemicals - efficient, hygienic, and hassle-free.

MenuPlanner

MenuPlanner allows you to cook many different items, unsupervised at the same time, using a simple drag and drop interface. Both experienced and inexperienced users will appreciate the automatic notifications that ensure efficient, precise and on-time consistency.

SmartChef

SmartChef helps you learn from the oven to develop your signature style. You select type of food, cooking method and temperature, and SmartChef will automatically guide you to a great result. Afterwards, you can save and, if necessary, edit the formula.

Electricity

Condensation hood

Invoq miniCombi 6-1/1 GN

Dimensions & weight



Dimensions excl. handle (HxWxD) [mm]	896 x 513 x 900
Dimensions incl. handle (HxWxD) [mm]	896 x 513 x 973
Dimensions incl. handle and basic stand (HxWxD) [mm]	1705 x 513 x 973
Shipping dimensions, oven (HxWxD) [mm]	930 x 560 x 935
Shipping dimensions, hood (HxWxD) [mm]*	230 x 580 x 920
Net weight, oven [kg]	67
Net weight, condensation hood [kg]*	18.5
Shipping weight, oven [kg]	74
Shipping weight, condensation hood [kg]*	22.5
Clearance (left, back, right) [mm]	50 x 0 x 50
Clearance (roof to ceiling) [mm]	300
Maximum working height [mm] table stand	427
Maximum working height [mm] basic stand	1236

Water requirements



Water connection [inches]	3/4
Drain [mm]	Ø40
Water pressure (min-max) [bar]	2.5-6
Water flow [l/m]	12

IP classification



IP class	IPX4
----------	------

Data



Wi-Fi module	IEEE 802.11 b/g/n (2.4 GHz)
LAN	RJ45

Power requirements



RCD model	B/F
Grid supply frequency [Hz]	50/60
Voltage 208 V 1PN AC	
Amperage [amp]	27
Pre-fuse [A]	32
Convection output [kW]	4.6
Voltage 230 V 1PN AC	
Amperage [amp]	27
Pre-fuse [A]	32
Convection output [kW]	5.6
Voltage 240 V 1PN AC	
Amperage [amp]	27
Pre-fuse [A]	32
Convection output [kW]	6.1
Voltage 400 V 3PN AC	
Amperage [amp]	14
Pre-fuse [A]	16
Convection output [kW]	8.4
Voltage 415 V 3PN AC	
Amperage [amp]	14
Pre-fuse [A]	16
Convection output [kW]	9.2

Hood power requirements



Voltage 24V AC (from oven)

- A Air intake filter
- B Detergent aid pump
- C Rinse aid pump
- D Potential equalization
- E Steam water inlet
- F Quench water inlet
- G Power inlet
- H Drain connection for Hoodini
- I Drain
- J Drain overflow port
- K Air inlet
- L Exhaust

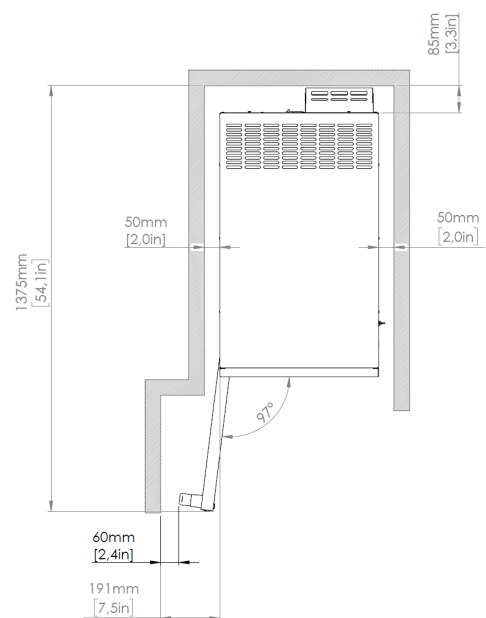
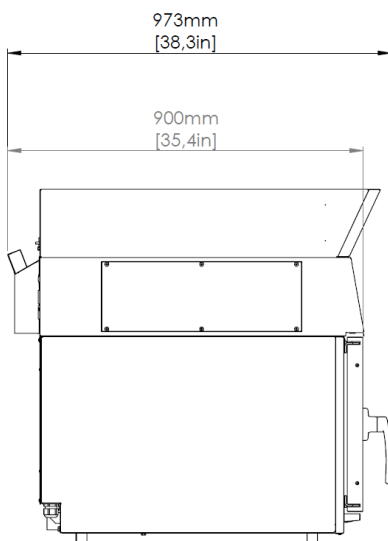
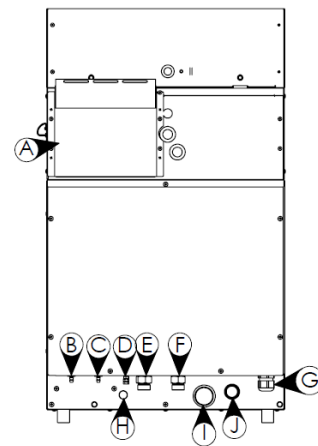
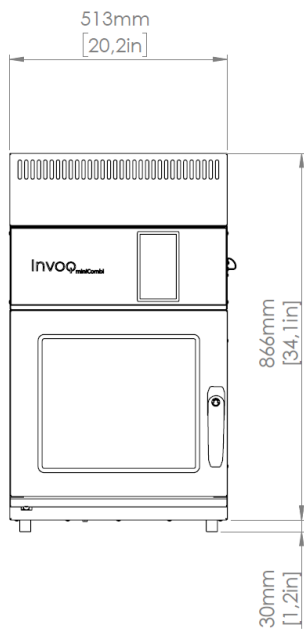

Electricity Hoodini

Invoq miniCombi 6-1/1 GN

Dimensions & weight



Dimensions incl. handle (HxWxD) [mm]	1145 x 514 x 1051
Dimensions incl. handle and basic stand (HxWxD) [mm]	1954 x 514 x 1051
Shipping dimensions (HxWxD) [mm]	1345 x 850 x 1200
Net weight [kg]	110
Shipping weight [kg]	127
Clearance (left, back, right) [mm]	50 x 0 x 50
Clearance (roof to ceiling) [mm]	300
Maximum working height [mm] table stand	427
Maximum working height [mm] basic stand	1236

Water requirements



Water connection [inches]	3/4
Drain [mm]	Ø40
Water pressure (min-max) [bar]	2.5-6
Water flow [l/m]	12

IP classification



IP class	IPX4
----------	------

Data



Wi-Fi module	IEEE 802.11 b/g/n (2.4 GHz)
LAN	RJ45

Power requirements



RCD model	B/F
Grid supply frequency [Hz]	50/60
Voltage 208 V 1PN AC	
Amperage [amp]	27
Pre-fuse [A]	32
Convection output [kW]	4.6
Voltage 230 V 1PN AC	
Amperage [amp]	27
Pre-fuse [A]	32
Convection output [kW]	5.6
Voltage 240 V 1PN AC	
Amperage [amp]	27
Pre-fuse [A]	32
Convection output [kW]	6.1
Voltage 400 V 3PN AC	
Amperage [amp]	14
Pre-fuse [A]	16
Convection output [kW]	8.4
Voltage 415 V 3PN AC	
Amperage [amp]	14
Pre-fuse [A]	16
Convection output [kW]	9.2

Hoodini power requirements



Voltage 208-240 V 1PN AC	
Power consumption [kW]	2.2
Amperage [A]	9

- A Air intake filter
- B Detergent aid pump
- C Rinse aid pump
- D Potential equalization
- E Steam water inlet
- F Quench water inlet
- G Power inlet
- H Drain connection for Hoodini
- I Drain
- J Drain overflow port
- K Air inlet
- L Exhaust

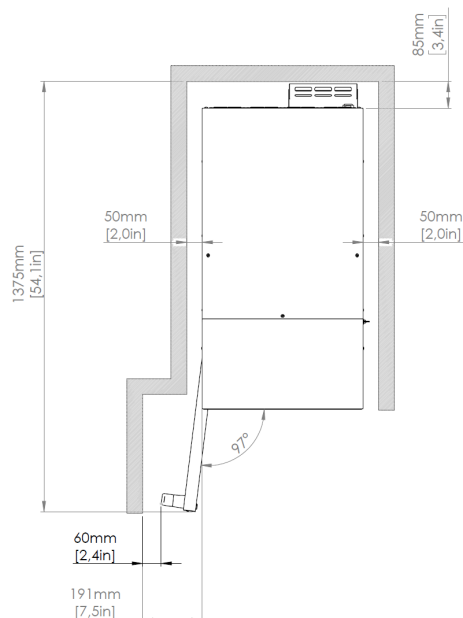
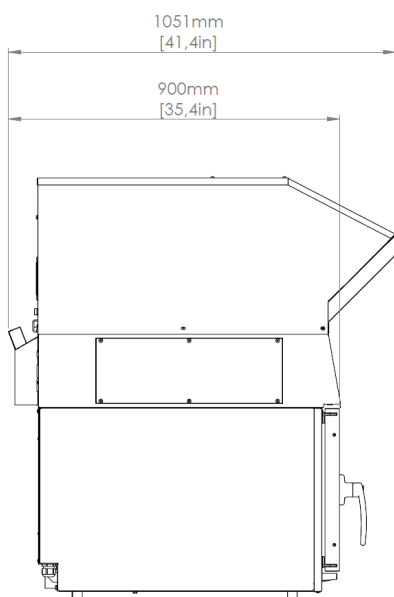
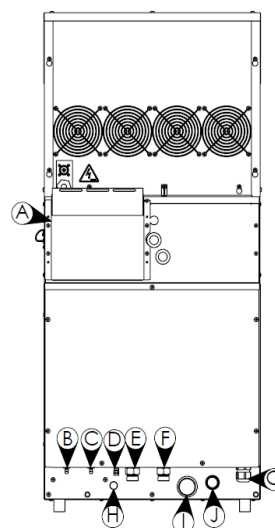
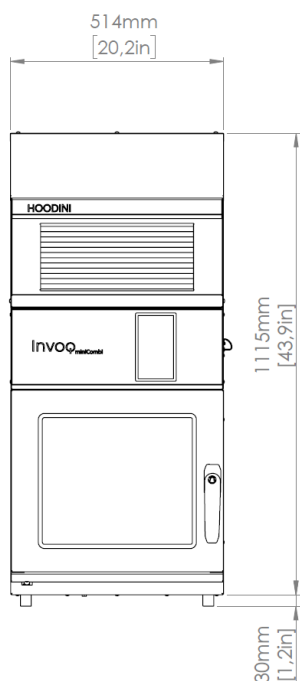

Electricity

Condensation hood

Invoq miniCombi 10-1/1 GN

Dimensions & weight



Dimensions excl. handle (HxWxD) [mm]	1096 x 513 x 900
Dimensions incl. handle (HxWxD) [mm]	1096 x 513 x 973
Dimensions incl. handle and table stand (HxWxD) [mm]	1905 x 513 x 973
Shipping dimensions, oven (HxWxD) [mm]	1130 x 560 x 935
Shipping dimensions, hood (HxWxD) [mm]*	230 x 580 x 920
Net weight, oven [kg]	81
Net weight, condensation hood [kg]*	18.5
Shipping weight, oven [kg]	88
Shipping weight, condensation hood [kg]*	22.5
Clearance (left, back, right) [mm]	50 x 0 x 50
Clearance (roof to ceiling) [mm]	300
Maximum working height [mm] table stand	627
Maximum working height [mm] basic stand	1436

Water requirements



Water connection [inches]	3/4
Drain [mm]	Ø40
Water pressure (min-max) [bar]	2.5-6
Water flow [l/m]	12

IP classification



IP class	IPX4
----------	------

Power requirements



RCD model	B/F
Grid supply frequency [Hz]	50/60
Voltage 400 V 3PN AC	
Amperage [amp]	21
Pre-fuse [A]	25
Convection output [kW]	12.7
Voltage 415 V 3PN AC	
Amperage [amp]	21
Pre-fuse [A]	25
Convection output [kW]	13.8

Data



Wi-Fi module	IEEE 802.11 b/g/n (2.4 GHz)
LAN	RJ45

Hood power requirements



Voltage 24V AC (from oven)

- A Air intake filter
- B Detergent aid pump
- C Rinse aid pump
- D Potential equalization
- E Steam water inlet
- F Quench water inlet
- G Power inlet
- H Drain connection for Hoodini
- I Drain
- J Drain overflow port
- K Air inlet
- L Exhaust

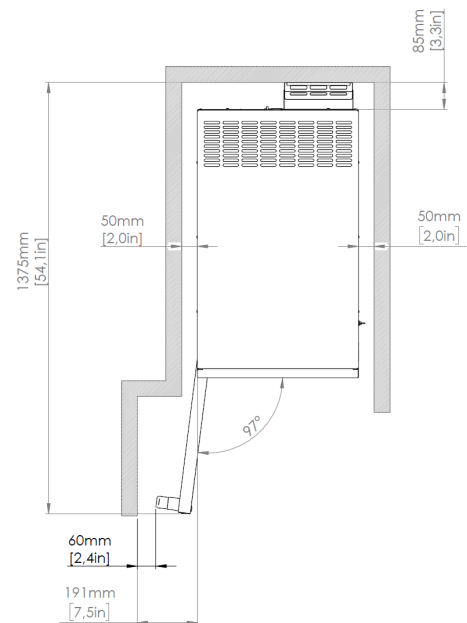
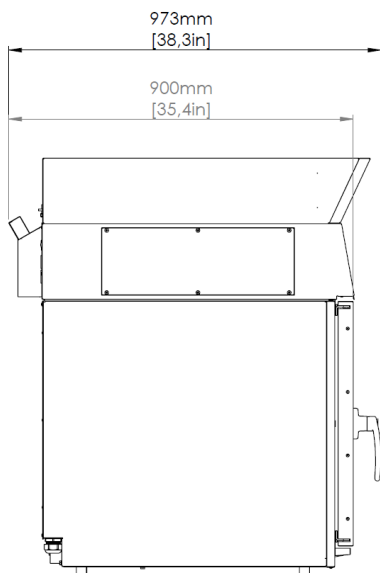
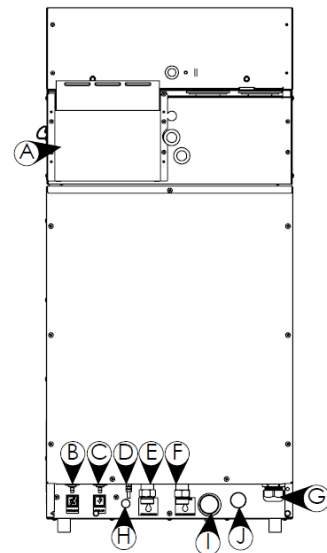
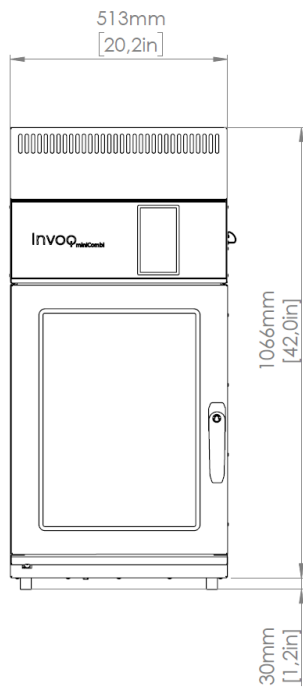

Electricity Hoodini

Invoq miniCombi 10-1/1 GN

Dimensions & weight



Dimensions incl. handle (HxWxD) [mm]	1345 x 514 x 1051
Dimensions incl. handle and basic stand (HxWxD) [mm]	2154 x 514 x 1051
Shipping dimensions (HxWxD) [mm]	1545 x 850 x 1200
Net weight [kg]	124
Shipping weight [kg]	141
Clearance (left, back, right) [mm]	50 x 0 x 50
Clearance (roof to ceiling) [mm]	300
Maximum working height [mm] table stand	627
Maximum working height [mm] basic stand	1436

Water requirements



Water connection [inches]	3/4
Drain [mm]	Ø40
Water pressure (min-max) [bar]	2.5-6
Water flow [l/m]	12

IP classification



IP class	IPX4
----------	------

Power requirements



RCD model	B/F
Grid supply frequency [Hz]	50/60
Voltage 400 V 3PN AC	
Amperage [amp]	21
Pre-fuse [A]	25
Convection output [kW]	12.7
Voltage 415 V 3PN AC	
Amperage [amp]	21
Pre-fuse [A]	25
Convection output [kW]	13.8

Data



Wi-Fi module	IEEE 802.11 b/g/n (2.4 GHz)
LAN	RJ45

Hoodini power requirements



Voltage 208-240 V 1 PN AC	
Power consumption [kW]	2.2
Amperage [A]	9

- A Air intake filter
- B Detergent aid pump
- C Rinse aid pump
- D Potential equalization
- E Steam water inlet
- F Quench water inlet
- G Power inlet
- H Drain connection for Hoodini
- I Drain
- J Drain overflow port
- K Air inlet
- L Exhaust

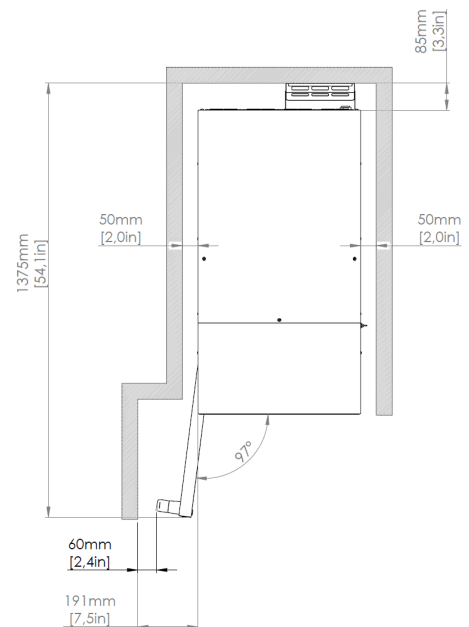
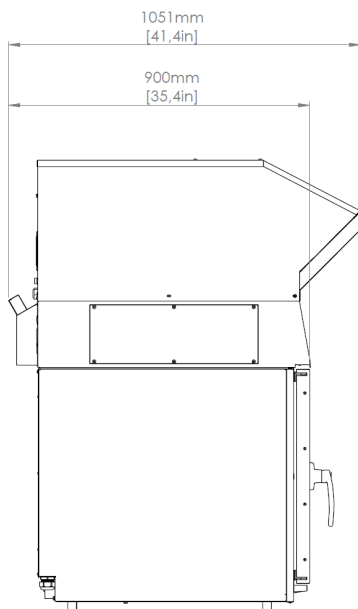
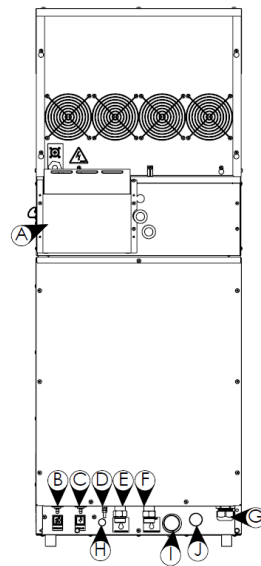
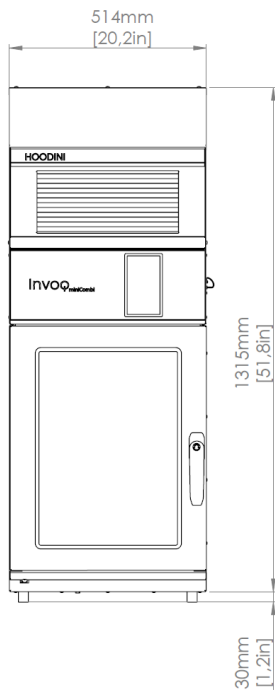

Electricity

Condensation hood

Invoq miniCombi 6-1/1 + 6-1/1 GN

Dimensions & weight



Dimensions excl. handle, incl Stackit stand (HxWxD) [mm]	1811 x 513 x 900
Dimensions incl. handle and Stackit stand (HxWxD) [mm]	1811 x 513 x 973
Shipping dimensions (HxWxD) [mm]	2011 x 850 x 1200
Shipping dimensions, hood (HxWxD) [mm]*	230 x 580 x 920
Net weight, oven [kg]	148
Net weight, condensation hood [kg]*	18.5
Shipping weight, oven [kg]	163
Shipping weight, condensation hood [kg]*	22.5
Clearance (left, back, right) [mm]	50 x 0 x 50
Clearance (roof to ceiling) [mm]	300
Maximum working height [mm] Stackit stand	1336

Water requirements



Water connection [inches]	3/4
Drain [mm]	Ø40
Water pressure (min-max) [bar]	2.5-6
Water flow [l/m]	12

IP classification



IP class	IPX4
----------	------

Data



Wi-Fi module	IEEE 802.11 b/g/n (2.4 GHz)
LAN	RJ45

*Condensation hood is shipped separately.
Condensation hood only on top oven.
Further technical information can be found in the installation manual.

Power requirements



	Top oven	Bottom oven
RCD model	B/F	B/F
Grid supply frequency [Hz]	50/60	50/60
Voltage 208 V 1PN AC		
Amperage [amp]	27	27
Pre-fuse [A]	32	32
Convection output [kW]	4.6	4.6
Voltage 230 V 1PN AC		
Amperage [amp]	27	27
Pre-fuse [A]	32	32
Convection output [kW]	5.6	5.6
Voltage 240 V 1PN AC		
Amperage [amp]	27	27
Pre-fuse [A]	32	32
Convection output [kW]	6.1	6.1
Voltage 400 V 3PN AC		
Amperage [amp]	14	14
Pre-fuse [A]	16	16
Convection output [kW]	8.4	8.4
Voltage 415 V 3PN AC		
Amperage [amp]	14	14
Pre-fuse [A]	16	16
Convection output [kW]	9.2	9.2

Hood power requirements



Voltage 24V AC (from oven)

- A Air intake filter
- B Detergent aid pump
- C Rinse aid pump
- D Potential equalization
- E Steam water inlet
- F Quench water inlet
- G Power inlet
- H Drain connection for Hoodini
- I Drain
- J Drain overflow port
- K Air inlet
- L Exhaust

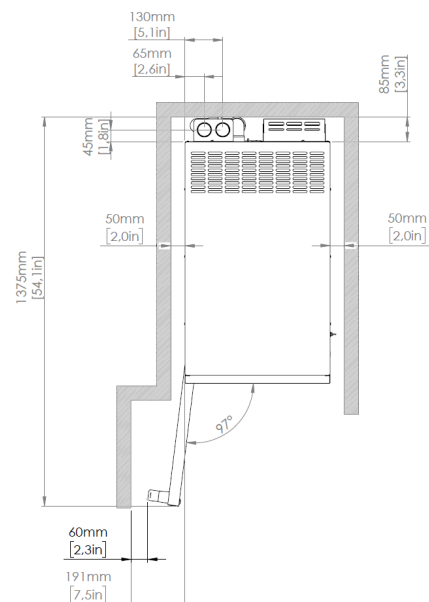
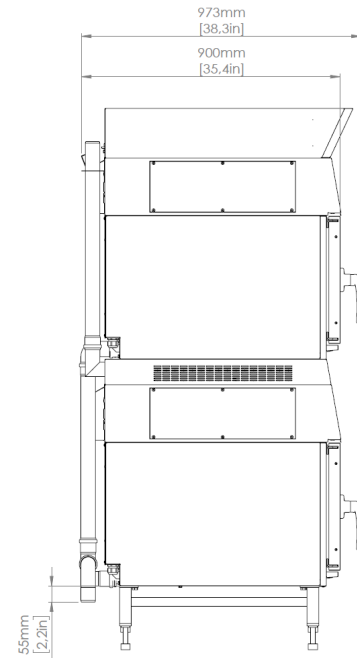
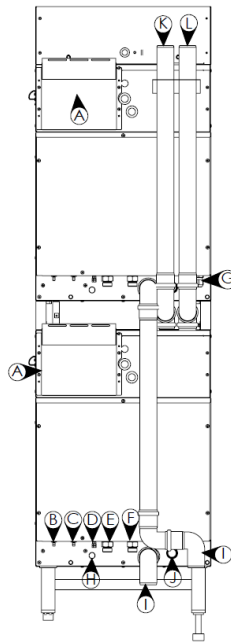
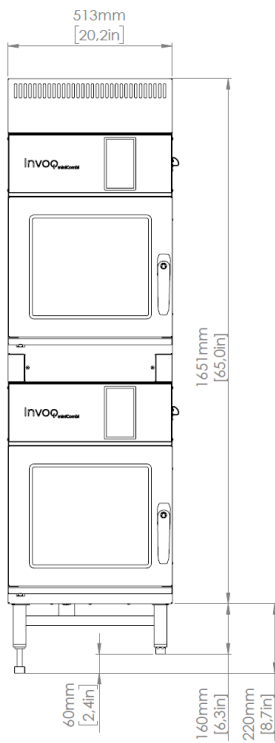

Electricity Hoodini

Invoq miniCombi 6-1/1 + 6-1/1 GN

Dimensions & weight



Dimensions incl. handle and Stackit stand (HxWxD) [mm]	2060 x 514 x 1051
Shipping dimensions (HxWxD) [mm]	2260 x 850 x 1200
Net weight [kg]	191
Shipping weight [kg]	206
Clearance (left, back, right) [mm]	50 x 0 x 50
Clearance (roof to ceiling) [mm]	300
Maximum working height [mm] Stackit stand	1336

Water requirements



Water connection [inches]	3/4
Drain [mm]	Ø40
Water pressure (min-max) [bar]	2.5-6
Water flow [l/m]	12

IP classification



IP class	IPX4
----------	------

Data



Wi-Fi module	IEEE 802.11 b/g/n (2.4 GHz)
LAN	RJ45

Hoodini only on top oven.
Further technical information can be found in the installation manual.

Power requirements



	Top oven	Bottom oven
RCD model	B/F	B/F
Grid supply frequency [Hz]	50/60	50/60
Voltage 208 V 1PN AC		
Amperage [amp]	27	27
Pre-fuse [A]	32	32
Convection output [kW]	4.6	4.6
Voltage 230 V 1PN AC		
Amperage [amp]	27	27
Pre-fuse [A]	32	32
Convection output [kW]	5.6	5.6
Voltage 240 V 1PN AC		
Amperage [amp]	27	27
Pre-fuse [A]	32	32
Convection output [kW]	6.1	6.1
Voltage 400 V 3PN AC		
Amperage [amp]	14	14
Pre-fuse [A]	16	16
Convection output [kW]	8.4	8.4
Voltage 415 V 3PN AC		
Amperage [amp]	14	14
Pre-fuse [A]	16	16
Convection output [kW]	9.2	9.2

Hoodini power requirements



Voltage 208-240 V 1 PN AC	
Power consumption [kW]	2.2
Amperage [A]	9

- A Air intake filter
- B Detergent aid pump
- C Rinse aid pump
- D Potential equalization
- E Steam water inlet
- F Quench water inlet
- G Power inlet
- H Drain connection for Hoodini
- I Drain
- J Drain overflow port
- K Air inlet
- L Exhaust

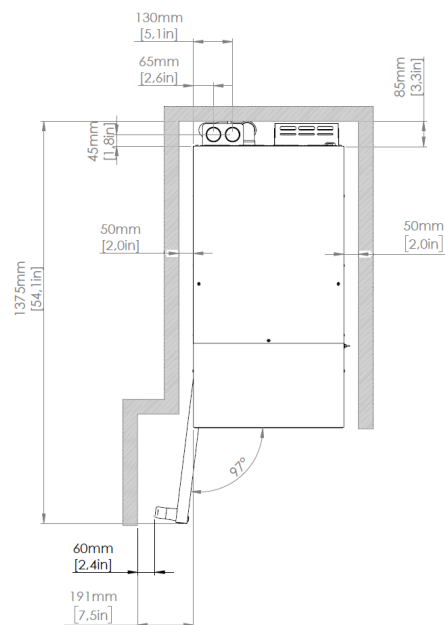
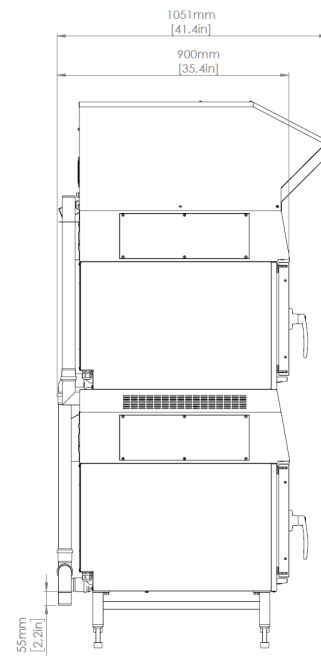
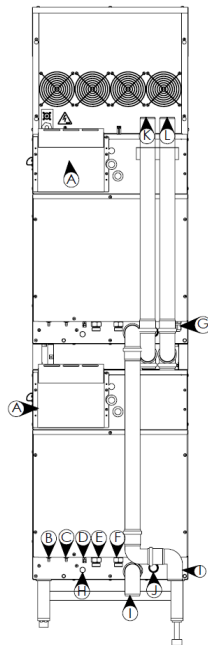
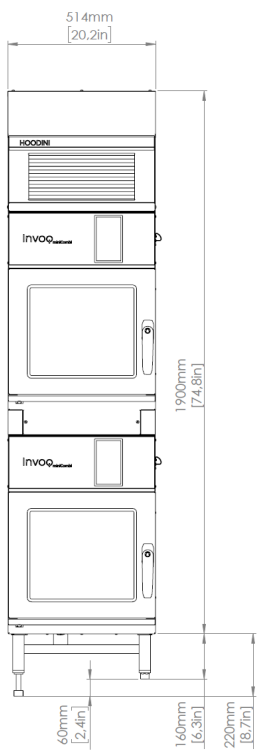

Electricity

Condensation hood

Invoq miniCombi 10-1/1 + 6-1/1 GN

Dimensions & weight



Dimensions excl. handle, incl Stackit stand (HxWxD) [mm]	2011 x 513 x 900
Dimensions incl. handle and Stackit stand (HxWxD) [mm]	2011 x 513 x 973
Shipping dimensions (HxWxD) [mm]	2211 x 850 x 1200
Shipping dimensions, hood (HxWxD) [mm]*	230 x 580 x 920
Net weight, oven [kg]	162
Net weight, condensation hood [kg]*	18.5
Shipping weight, oven [kg]	177
Shipping weight, condensation hood [kg]*	22.5
Clearance (left, back, right) [mm]	50 x 0 x 50
Clearance (roof to ceiling) [mm]	300
Maximum working height [mm] Stackit stand	1539

Water requirements



Water connection [inches]	3/4
Drain [mm]	Ø40
Water pressure (min-max) [bar]	2.5-6
Water flow [l/m]	12

IP classification



IP class	IPX4
----------	------

Data



Wi-Fi module	IEEE 802.11 b/g/n (2.4 GHz)
LAN	RJ45

Power requirements



	Top oven	Bottom oven
RCD model	B/F	B/F
Grid supply frequency [Hz]	50/60	50/60
Voltage 400 V 3PN AC		
Amperage [amp]	14	21
Pre-fuse [A]	16	25
Convection output [kW]	8.4	12.7
Voltage 415 V 3PN AC		
Amperage [amp]	14	21
Pre-fuse [A]	16	25
Convection output [kW]	9.2	13.8

Hood power requirements



Voltage 24V AC (from oven)

*Condensation hood is shipped separately.
Condensation hood only on top oven.
Further technical information can be found in the installation manual.

- A Air intake filter
- B Detergent aid pump
- C Rinse aid pump
- D Potential equalization
- E Steam water inlet
- F Quench water inlet
- G Power inlet
- H Drain connection for Hoodini
- I Drain
- J Drain overflow port
- K Air inlet
- L Exhaust

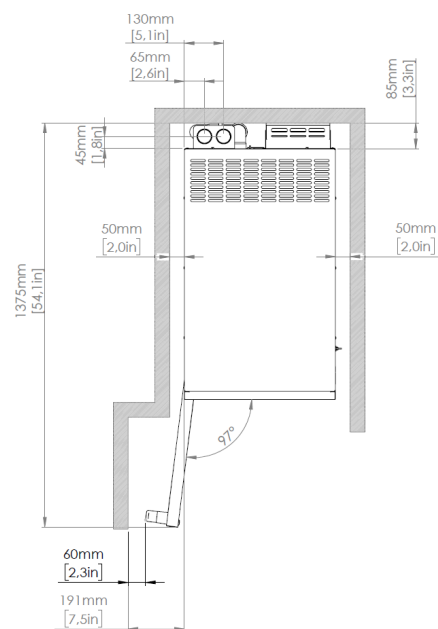
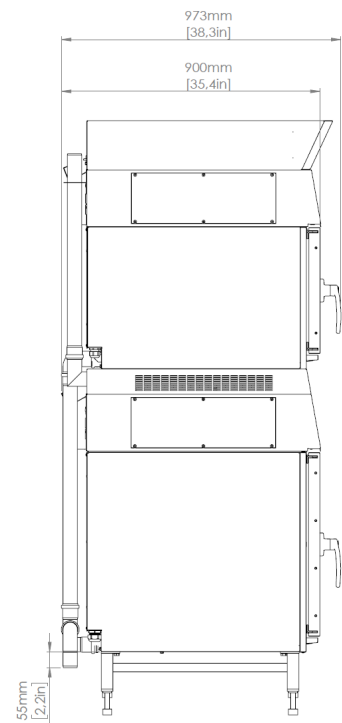
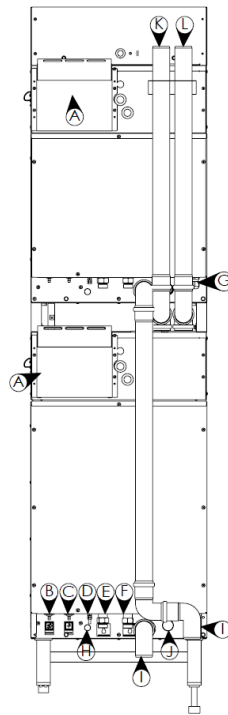
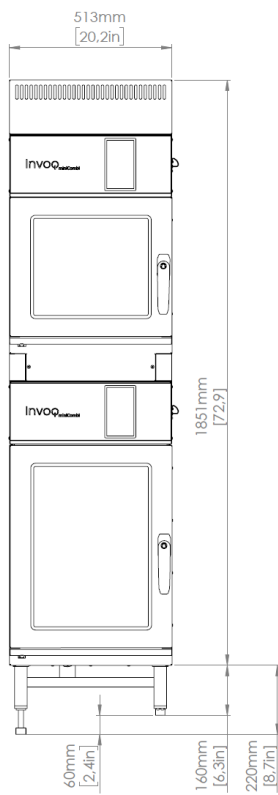

Electricity Hoodini

Invoq miniCombi 10-1/1 + 6-1/1 GN

Dimensions & weight



Dimensions incl. handle and Stackit stand (HxWxD) [mm]	2260 x 514 x 1051
Shipping dimensions (HxWxD) [mm]	2460 x 850 x 1200
Net weight [kg]	205
Shipping weight [kg]	220
Clearance (left, back, right) [mm]	50 x 0 x 50
Clearance (roof to ceiling) [mm]	300
Maximum working height [mm] Stackit stand	1539

Water requirements



Water connection [inches]	3/4
Drain [mm]	Ø40
Water pressure (min-max) [bar]	2.5-6
Water flow [l/m]	12

IP classification



IP class	IPX4
----------	------

Data



Wi-Fi module	IEEE 802.11 b/g/n (2.4 GHz)
LAN	RJ45

Power requirements



	Top oven	Bottom oven
RCD model	B/F	B/F
Grid supply frequency [Hz]	50/60	50/60
Voltage 400 V 3PN AC		
Amperage [amp]	14	21
Pre-fuse [A]	16	25
Convection output [kW]	8.4	12.7
Voltage 415 V 3PN AC		
Amperage [amp]	14	21
Pre-fuse [A]	16	25
Convection output [kW]	9.2	13.8

Hoodini power requirements



Voltage 208-240 V 1 PN AC	
Power consumption [kW]	2.2
Amperage [A]	9

- A Air intake filter
- B Detergent aid pump
- C Rinse aid pump
- D Potential equalization
- E Steam water inlet
- F Quench water inlet
- G Power inlet
- H Drain connection for Hoodini
- I Drain
- J Drain overflow port
- K Air inlet
- L Exhaust

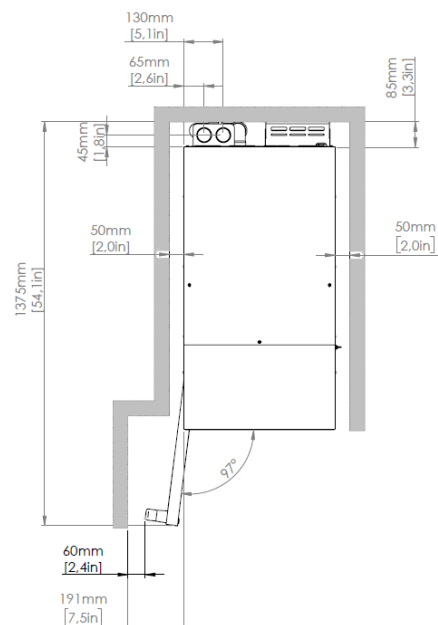
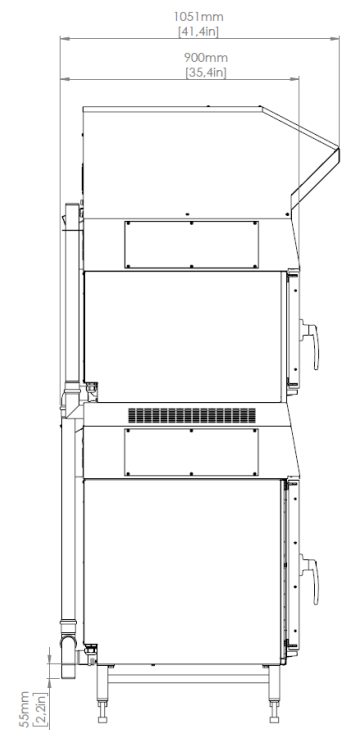
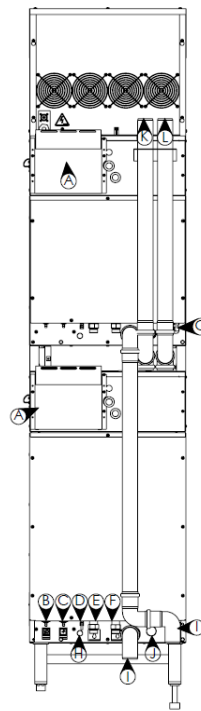
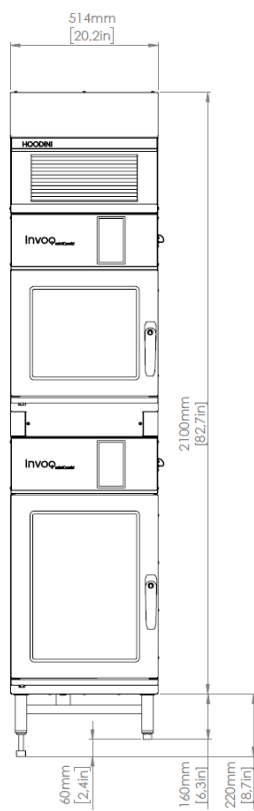

Features

Intelligence

CombiWash	Fully automatic, liquid-based cleaning system. The red tube delivers detergent, while the blue tube supplies rinse aid. Cleaning programs include flush, light, medium, heavy, intensive. Automatic safety flush after interrupted cleaning cycle.
MenuPlanner	Up to 10 integrated timers for notifications. Software to input and group recipes with drag and drop functionality. Automatic alert to request staggering of loading when grouping up to three specific recipes.
CookTimeCorrection (CTC)	Intelligent sensors detecting unexpected changes in temperature and compensating accordingly.
SmartChef	Intelligent cooking automation selecting the optimal cooking settings.
Humidity control, CombiSpeed	Level-controlled humidity injection for improving low-temperature cooking optimising tenderisation and yield of larger products. 10 different humidity levels.
QSR	QSR, Quick Select Recipes, is a tailored smart user interface allowing recipes as favourites on the home screen. 9 thumbnail recipes per page - up to 9 pages for a total of 81 recipes. Option of locked down user interface to prevent manual operation.
Connectivity, Open Kitchen	Cloud solution for menu management, recipe distribution, preventive maintenance, real-time overview of fleet, food safety documentation and consumption data overview.
Power failure	Automatic restart after power failure allowed up to 30 minutes to ensure finalisation of running programs. Automatic rinse after interrupted cleaning process for safe cooking. User notification of failure occurred and documents via HACCP.

Operation

Convection, temperature range	30-300°C / 85°-572°F 300°C / 572°F possible for 15 minutes, then reducing to 250°C / 480°F for continued run in manual mode.
Steam, temperature range	30-130°C / 85°-265°F Injection steam for rapid and pure steam for optimal performance even at low temperatures below 100°C / 212°F.
CombiSpeed, temperature range	30-250°C / 85-480°F CombiSpeed: Power steam adjustable in 10 levels for reduced cooking time and tenderizing products.
Cool down	Rapid cool down function with possibility for doing it with the door open or by use of water.
Proving	Humidity regulated proving function for optimum proving of baked products

Operation

InjectionSteam	In steaming mode, steam is generated by injecting water directly on to the heating elements and circulating it with the fan creating fast and efficient steam.
Steam on demand	Push and hold in manual mode or push and select between 1-30 seconds.
Steam on demand in recipes	Programmable steam on demand between 1-30 seconds. Pause can be added between steps for optimal crust.
Recipes	<p>The oven can hold 1,500 recipes.</p> <p>Each recipe can hold up to 15 different steps.</p> <p>A set of preset recipes are installed on the oven from factory.</p> <p>Recipes can be grouped, e.g. bakery products, Italian cuisine.</p> <p>Choose from icons or photos, available from a preinstalled library, or upload own images.</p> <p>Simple upload or transfer between Invoq ovens via USB or the cloud solution.</p>
Delta-T	Cooking method based on the product's core temperature for gentle preparation tenderising meat and reducing shrinkage.
Cook & Hold	Cooking method using Delta-T as cooking mode until just before the desired temperature is reached after which the temperature is maintained, while automatic humidity control ensures the optimal conditions with a high moisture level and minimum shrinkage.
Temperature probe	Internal multipoint core temperature probe with accurate sensors. Always at ambient temperature. for easy use.

Safety

Fan wheel brake	Rapid fan stop.
Overheat protection	Overheating protection for convection heat and steam generator.
Contact temperature	Maximum contact temperature of oven door 70°C.
Dual pane glass door	Dual pane glass ensures that the temperature on the outside of the oven door remains safe.
HACCP	<p>HACCP files are automatically stored for 60 days and can be downloaded in PDF format to ensure food safety documentation. Stored on the oven when not connected.</p> <p>HACCP data includes production time, production duration, preparation temperature and core temperature.</p>
Maximum rack height	Maximum working height of 1.45 m.
Display lock	Ensuring no interruption with operation when cleaning the surface.
IP protection	Protection class IPX4 protecting against splashes of water.
Door handle	Two-step safety handle as standard.
Cavity	DIN 1.4301 steel with seamless welding and rounded corners for optimal airflow and cleaning.

Network

USB	Integrated USB interface for software, recipe and HACCP handling.
LAN	Ethernet interface for wired connectivity to Open Kitchen.
Wi-Fi	WLAN for wireless connectivity to Open Kitchen.
Connectivity	Open Kitchen cloud-based system enabling management of oven fleet and general facility management.

Care

CareCycle	Fully automatic, liquid-based cleaning system with 5 cycles. Automatic flush after interrupted cleaning cycle ensuring no chemical residue left in the chamber.
HydroShield	Use carbon filtered water removing lime and gypsum.
Dual pane glass door	Swivelling glass panes for easy cleaning.
Hand shower	Hand shower can be an add-on to be located on the side, with separate closing mechanism. The external hand shower is designed with focus on ergonomics and work environment.
External	Easy external clean due to stainless steel and glass surfaces and IPX4 protection.
Connectivity	Monitoring and consumption overview via the Open Kitchen cloud solution.

Comfort

Time format	Adjustable in 24-hour format or am/pm.
Timer start	Customisable automatic timer starts. Allowing the oven to start and/or preheat unsupervised.
Timer modes	HH:MM - MM:SS - continuous time
Display	Digital temperature display adjustable in °C or °F, display of target and actual values.
Fan speed	1 fan wheel. Reversible fan ensuring uniform results. Optimum distribution of air and steam in oven chamber. Adjustable fan with 9 steps (20-100%); low fan speed - ideal for light/delicate products The fan can be set manually in convection, steaming and regeneration mode. In all other modes, the fan function is set automatically.
Lighting	Interior halogen lighting with high illumination of cooking chamber.
Touch display	Fast reacting and intuitive touch display for smooth and easy operation.
User interface	Capacitive 7" TFT colour touch screen with super wide view for optimal viewing angles. Simple and intuitive operation by self explanatory symbols and guidance eases the operation like a smartphone, operated by Android 9. Compatible with Middleby UI for multi devices with same control.
Languages	27 languages preset for operation and trouble shooting.
Cooking methods	6 operating modes and/or 5 cooking modes.
Supervision access	View or change the operating mode.
Customisation	Customise the home screen to allow easier access to favourites, cleaning and MenuPlanner removing the risk of operator errors. Customise notes with alarms to guide staff. Incorporate guidelines to recipes for optimal usage and elimination of errors.

Installation, maintenance & environment

Start widget	Correct and stress-free installation incl. location (sea level) customisation.
Service widget	Correct and easy maintenance incl service diagnosis and self-test functionality.
Fitting	Left- or right-hinged door for optimal ergonomics and kitchen design.
Service access	Easy service access through inspection hatches on the sides.
Water filtration	HydroShield water treatment is recommended for optimal operation. User notification by oven for replacement.
Connectivity	Remote diagnosis and updates with Open Kitchen.
Warranty	Standard warranty or extended according to purchase agreement with distributor.
Maintenance	Regular maintenance is recommended according to the manufacturer's guideline by trained service partners.
Ambient temperature	Maximum 50°C ambient operation temperature.

Options

Right-hinged door
Condensation hood
Hoodini ventless hood
Stackit 1/1 GN
Handshower
Open Kitchen cloud solution

Stands

Basic stand
Stand for Stackit
Options for stand (add-on):
Racks 1/1 GN
Holder for filter & chemicals

CombiWash

Detergent intense
RinseAid
HydroShield L 3600 Complete
HydroShield XL 6000 Complete
HydroShield L 3600 Replacement filter
HydroShield XL 6000 Replacement filter

Accessories

6-1/1 GN power supply cable 5.5 meter,
electric 400 V 3PN AC, 5x2.5 mm²
Installation kit
USB key
Prepared for IEMS energy management
system

GET IN TOUCH.

As your oven specialist,
we always do our
utmost to help our
customers. Worldwide.

HOUNÖ A/S
Alsvej 1
DK-8940 Randers SV
Denmark

T: +45 8711 4711
M: houno@houno.com

www.houno.com

Part of

