



TEPPANYAKI PLATE

20mm thick Plate

TK24 - Gas

- 20mm thick mild steel plate maximises heat retention for consistent cooking
- Heavy duty cast iron 40 Mj/hr burner
- Stainless steel hob, fascia and plate surround for easy cleaning

Other options

Stand or bench mounted

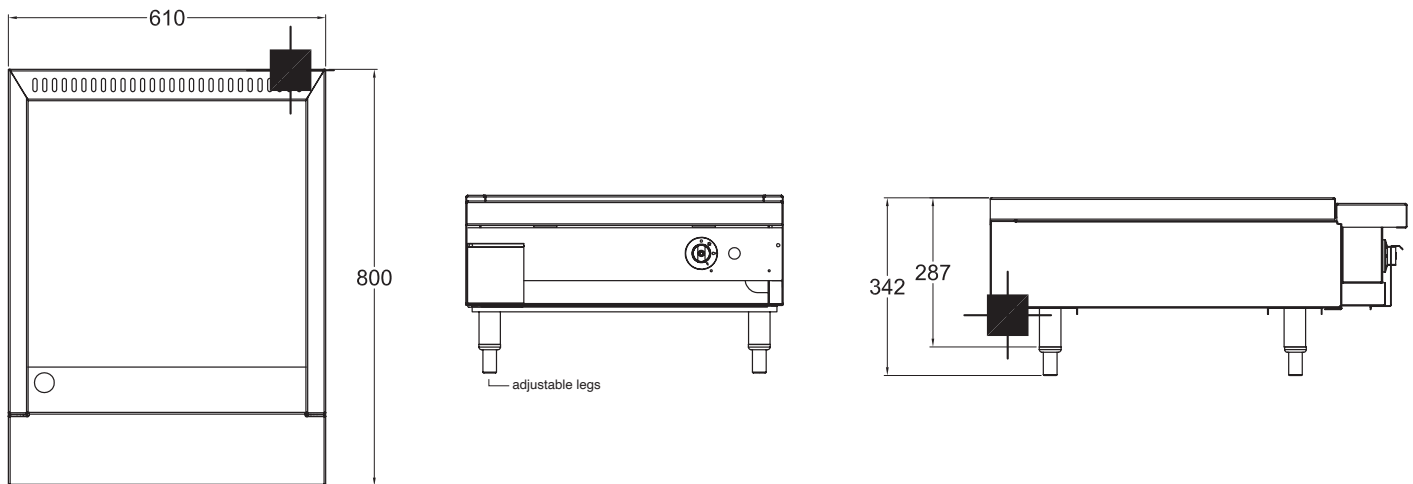

TK24

SPECIFICATIONS

Dimensions (WxDxH)	610 x 800 x 345 mm
Plate Size (WxDxH)	527 x 524 x 20 mm
Gas Connection	3/4" BSP

3/4" BSP Gas Connection

Rating	40 Mj
Weight	60 kg
Packed	0.2 m ³

Australia's premier food service equipment manufacturer

middleby.com.au

211-217 Woodpark Road, Smithfield NSW 2164
1800 013 123 | +61 2 9604 7333

 **MIDDLEBY AUSTRALIA**

